

PAS-448

WVA 29030

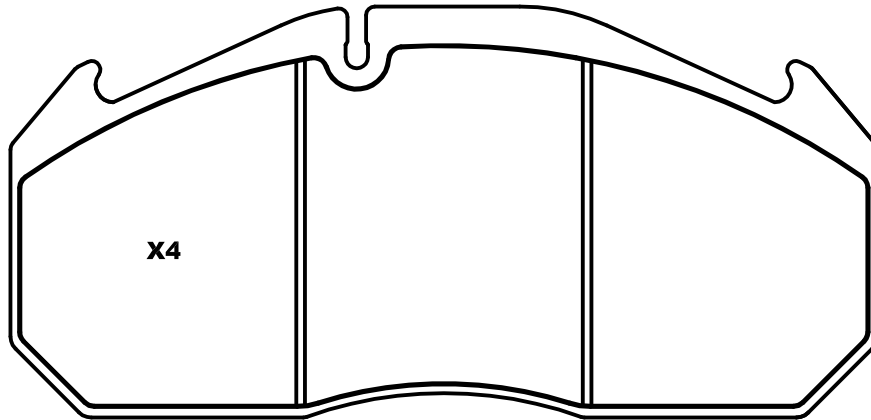

ACC-804

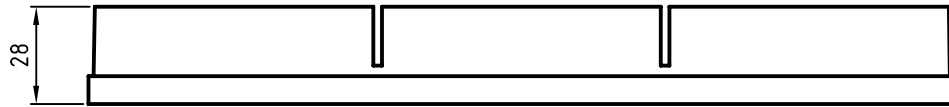
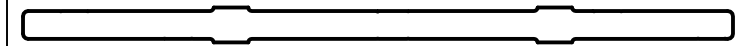
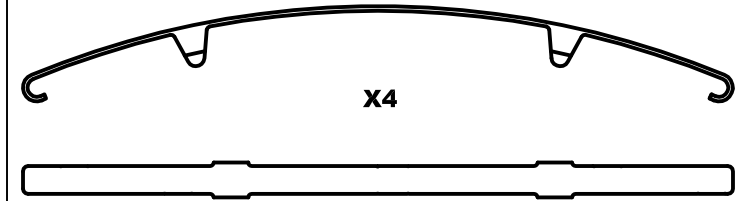

ACB-102

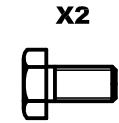

PAS-502

WVA 29090

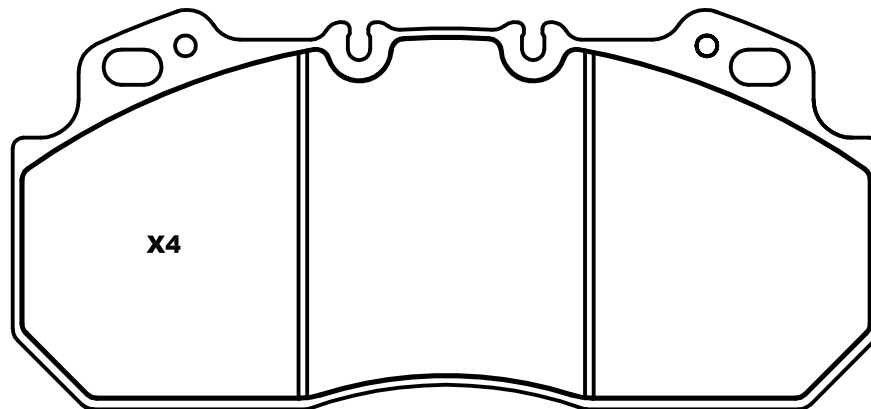
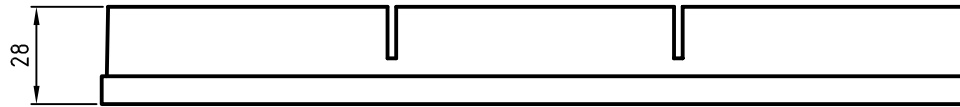

ACC-802

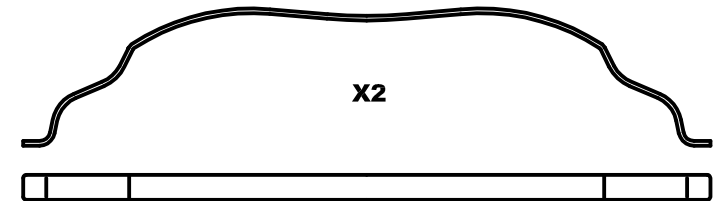

ACK-103

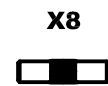
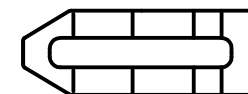

PAS-510

WVA 29088

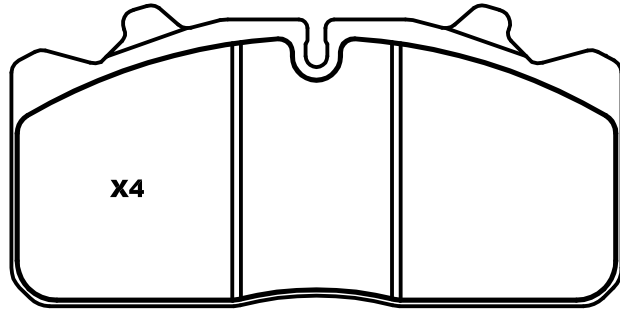
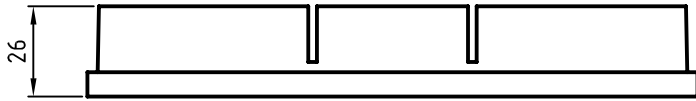

ACK-206

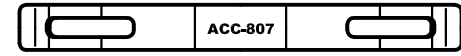
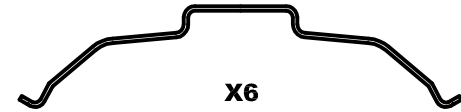

X2



X2

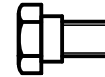

PAS-544

WVA 29124

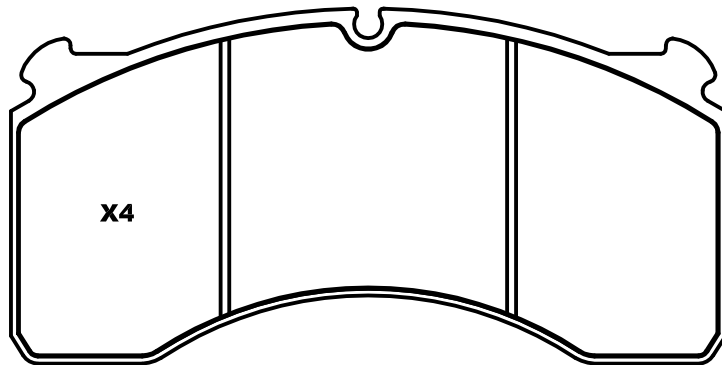
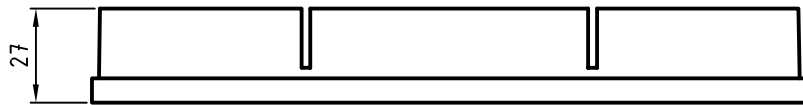

ACK-110

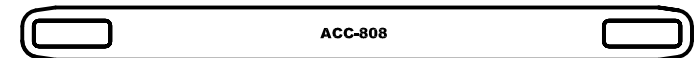
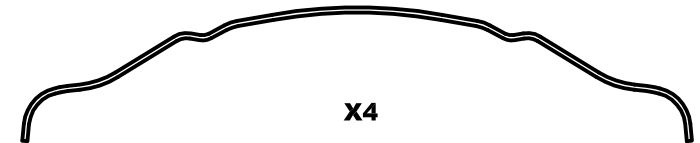

X2



X2



X2



X2

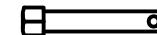

X2



PAS-547

WVA 29125

29.25

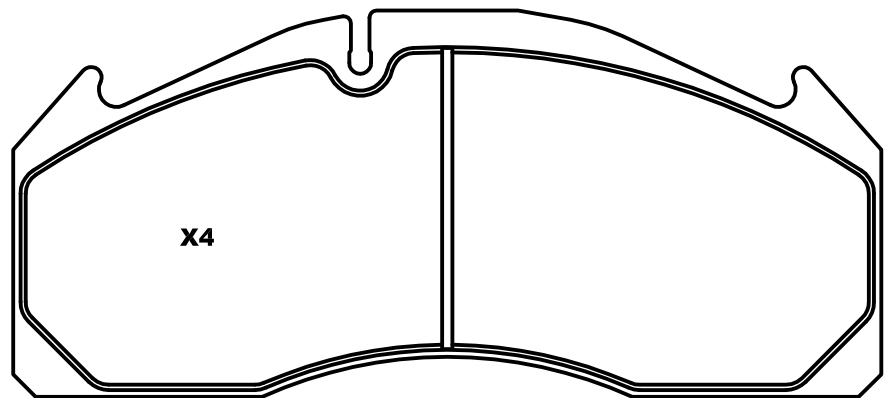
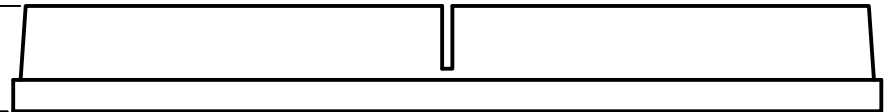

X4

ACC-817



X4

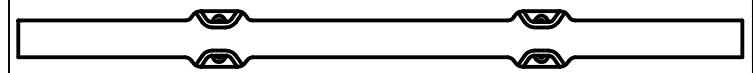

ACB-101

X2

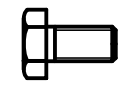

PAS-552

WVA 29159

29.95

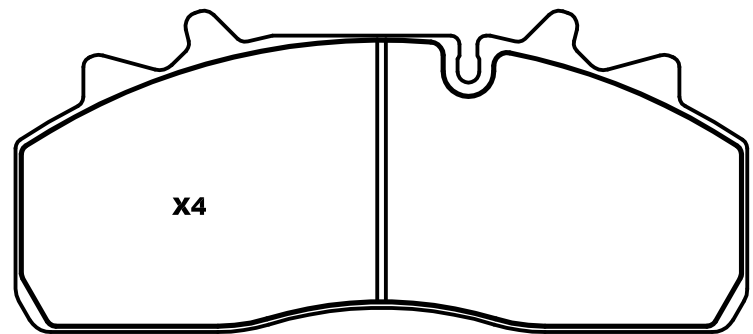
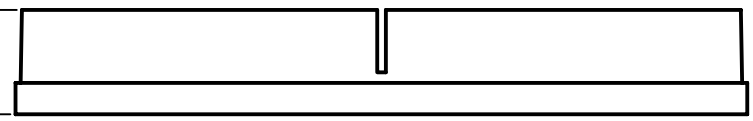

X4

ACK-207

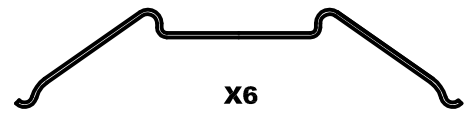

X6

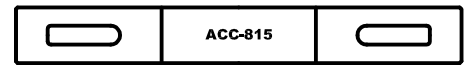

X2



X2

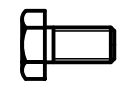

PAS-555

WVA 29137

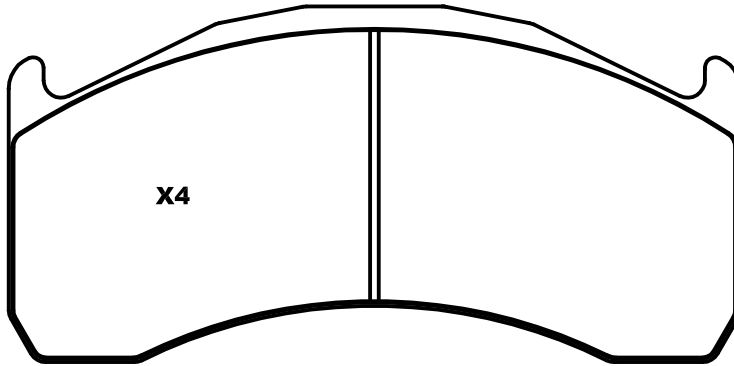
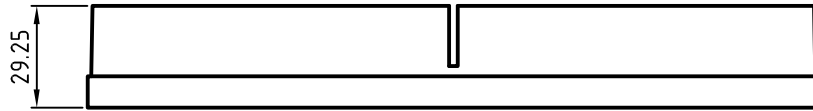

ACC-811

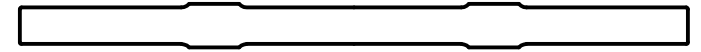
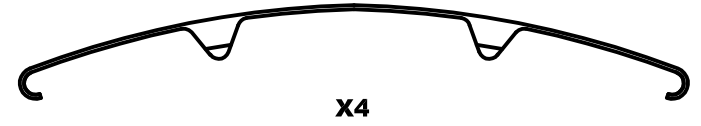

ACB-101

X2

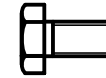

PAS-556

WVA 29136

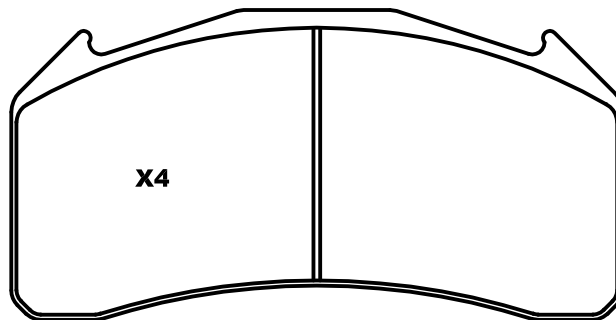

ACC-822

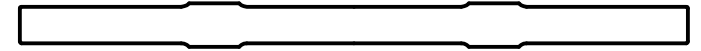
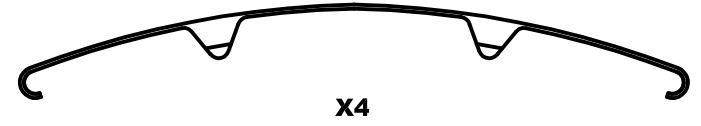

ACB-101

X2

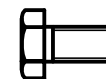

PAS-557

WVA 29131

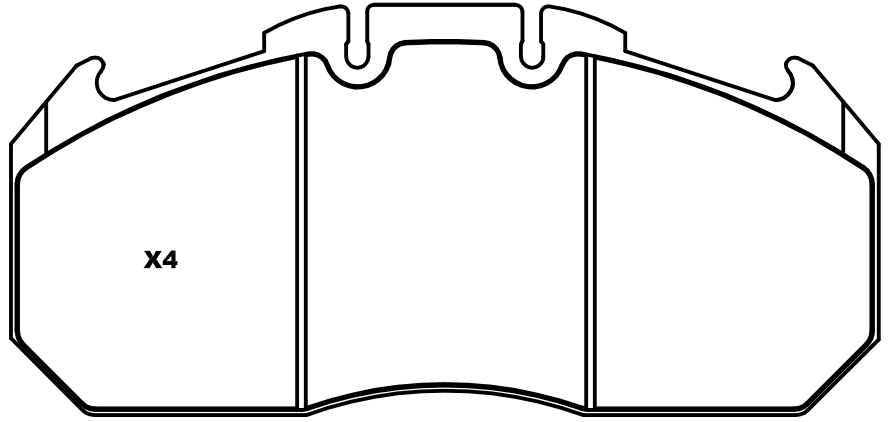
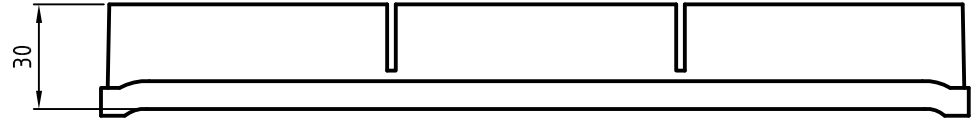

ACC-804

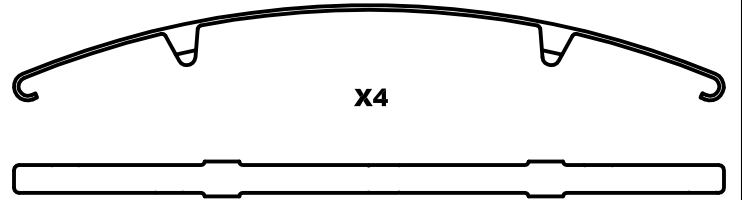

ACB-101

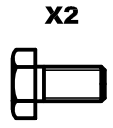

PAS-563

WVA 29141

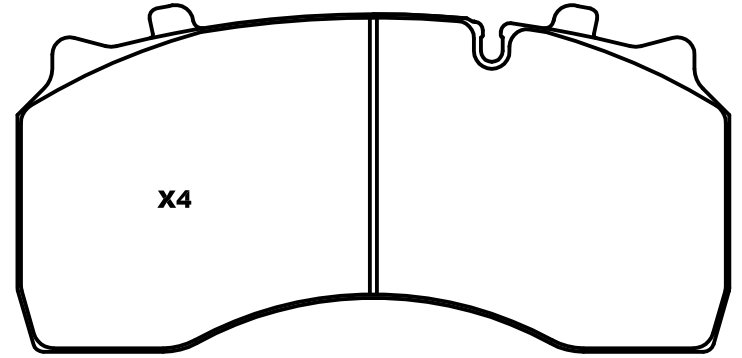
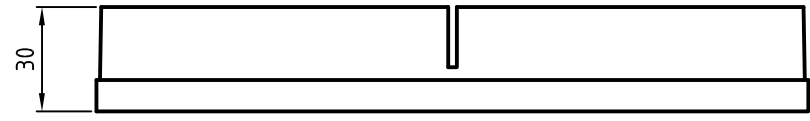

ACK-211

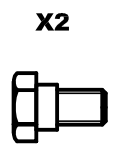
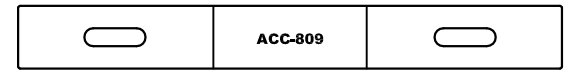
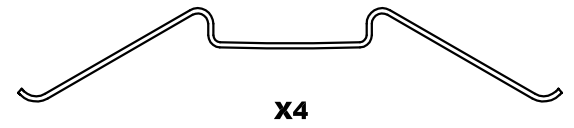

PAS-564

WVA 29142

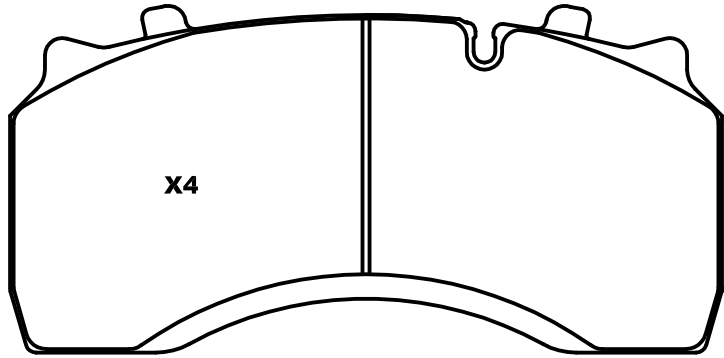
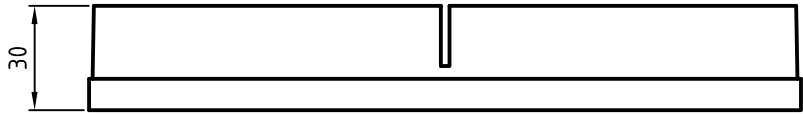

ACK-211

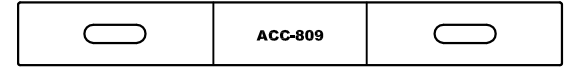

ACC-809

X4

X2

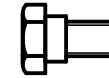

PAS-606

WVA 29162

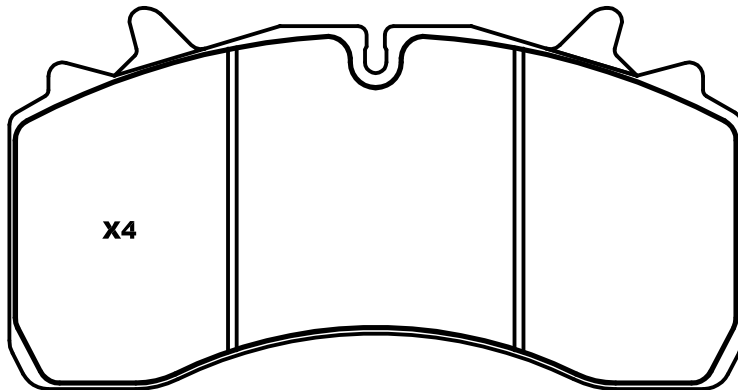
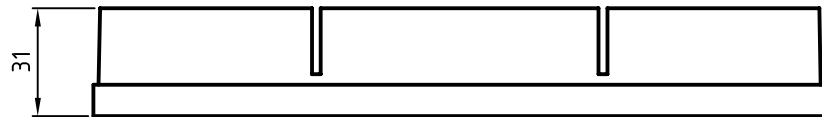

ACK-208

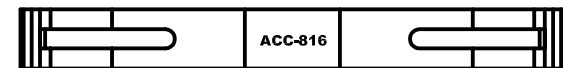
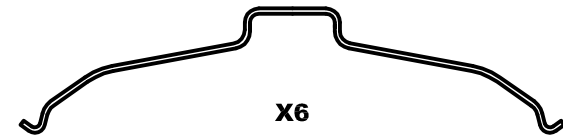

ACC-816

X2

X2

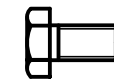

PAS-608

WVA 29165

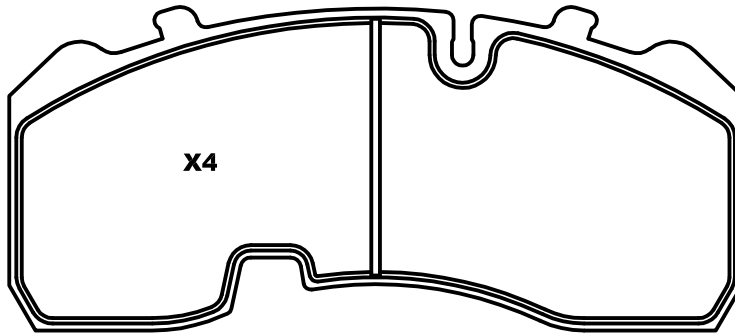
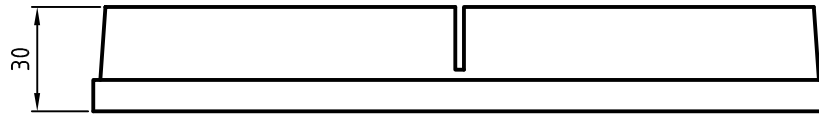

ACC-801



ACK-201

X1



X2



X2

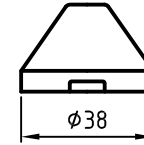

X2

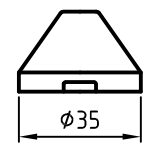

X2

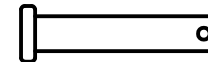

X2



X2



PAS-609

WVA 29171

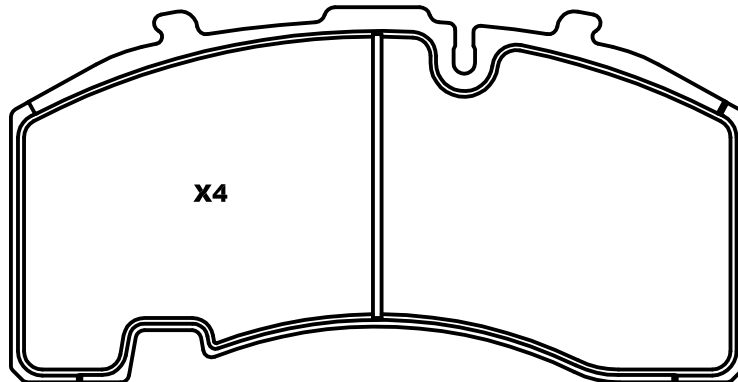
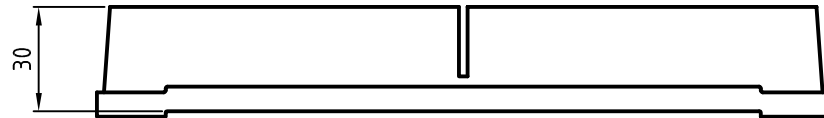

ACC-801

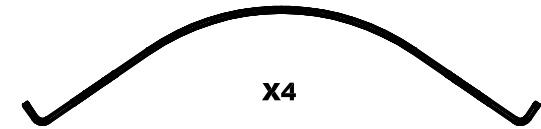

ACK-201

X1



X2



X2

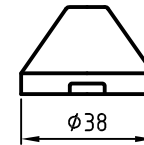

X2

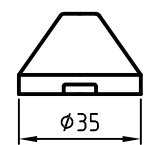

X2

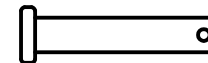

X2



X2



PAS-610

WVA 29167

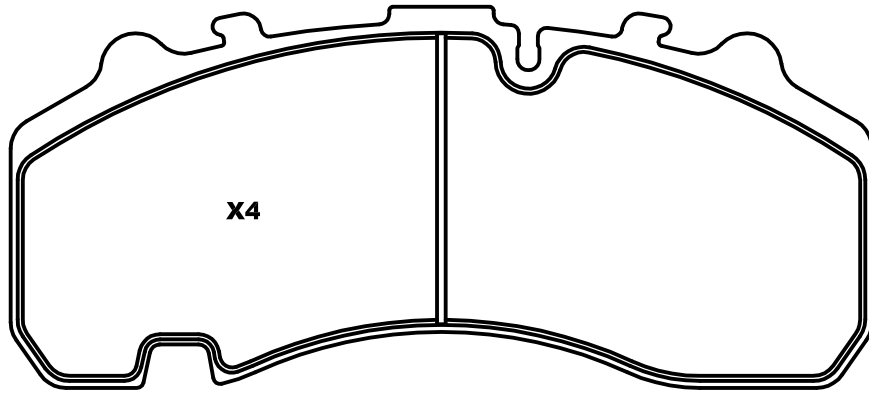
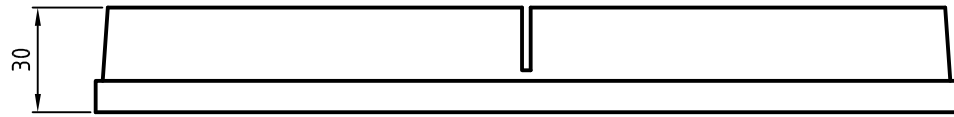

ACC-801

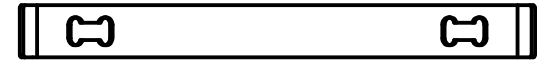

ACK-201

X1



X2



X2

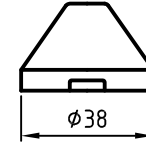

X2

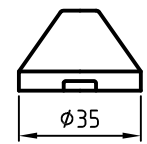

X2

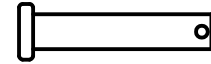

X2



X2



PAS-617

WVA 29169

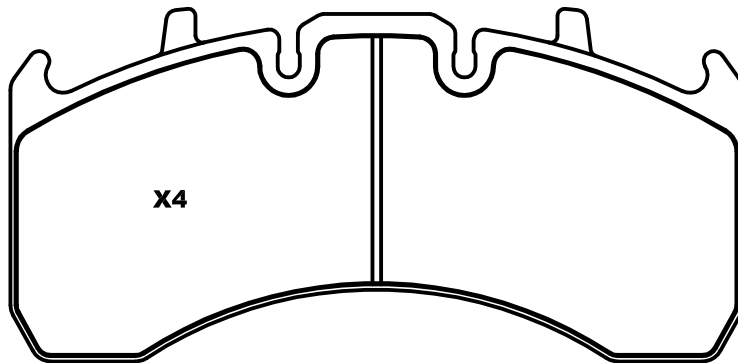
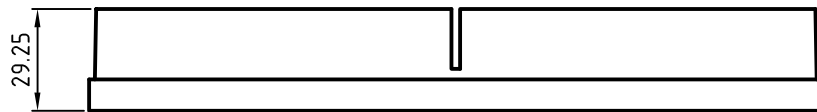

ACC-814

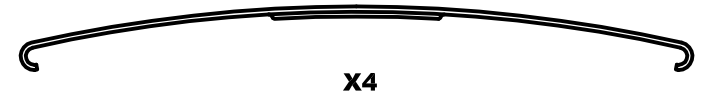

ACB-101

X2

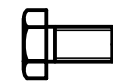



PAS-623

WVA 29115

WVA 29116

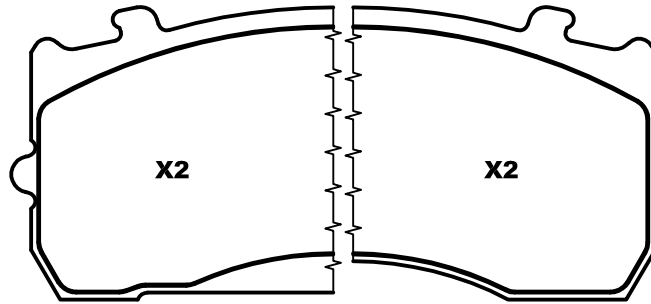
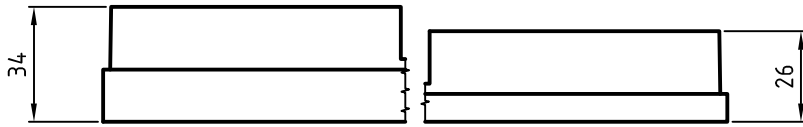

ACC-801

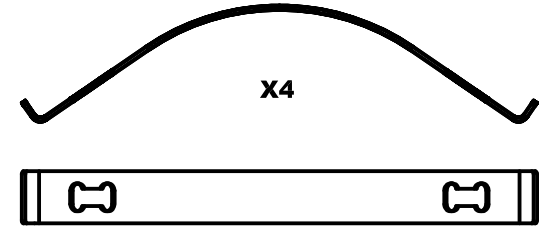

ACK-101

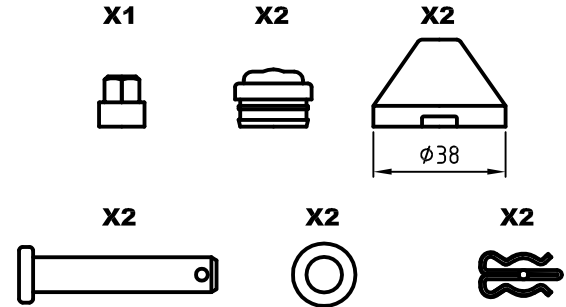

PAS-624

WVA 29093

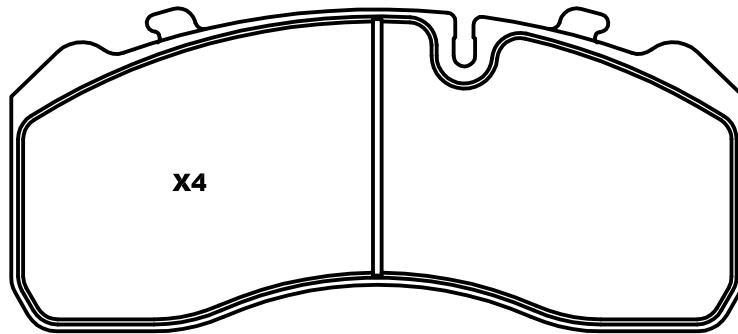
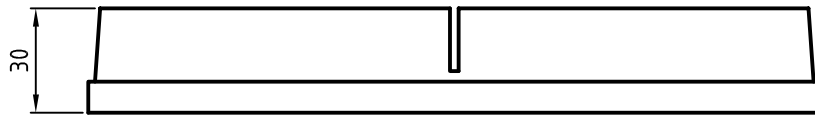

ACC-801

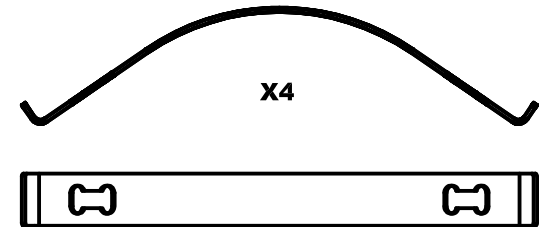

ACK-101

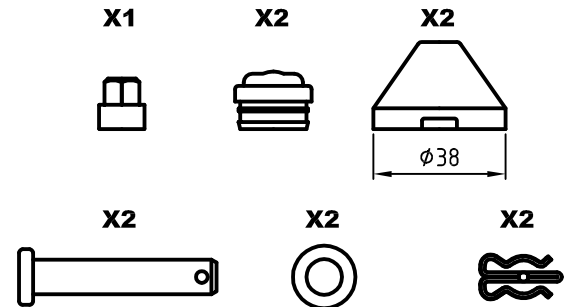

PAS-625 WVA 29087

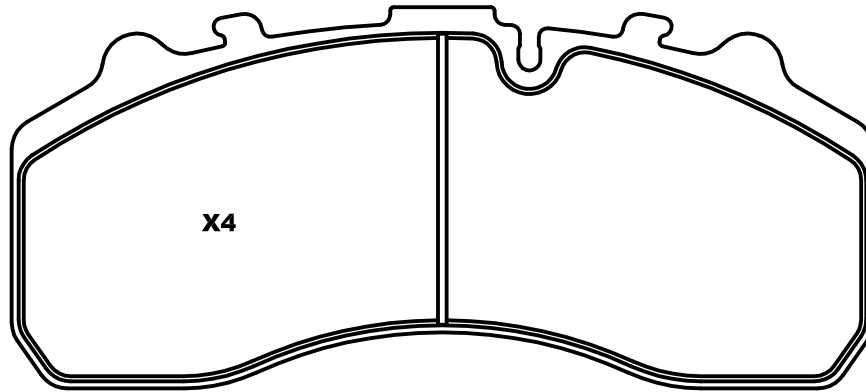
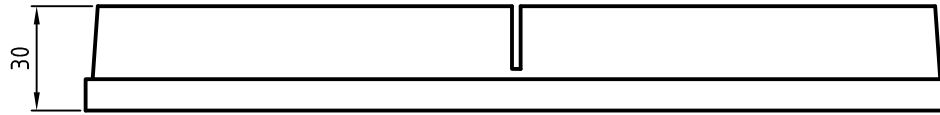

ACC-801

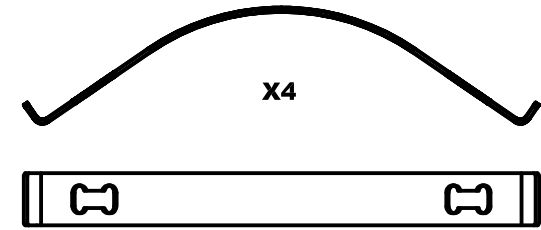

ACK-101

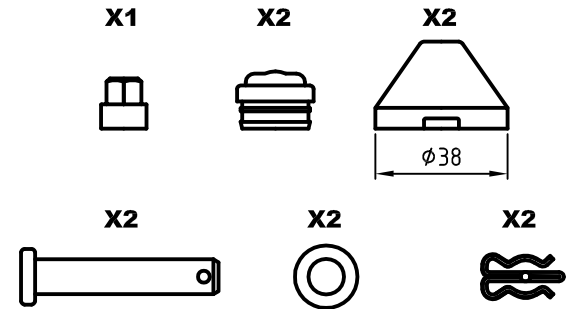

PAS-631 WVA 29174

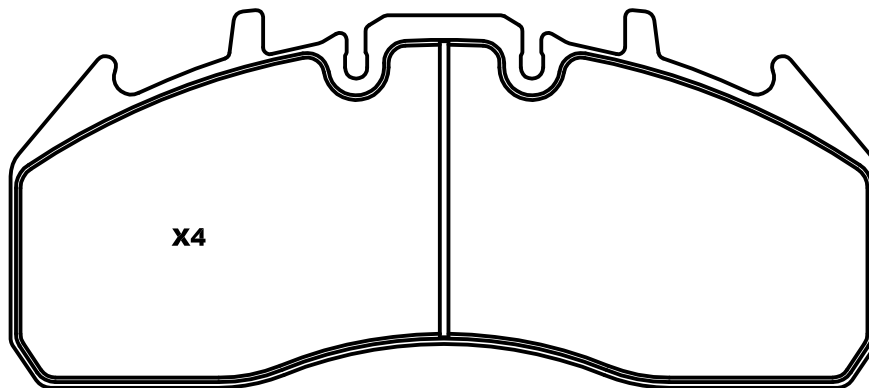
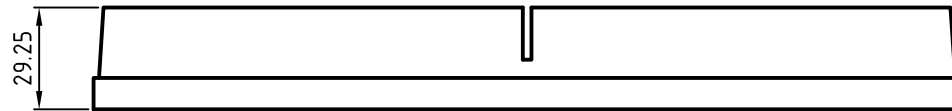

ACC-814

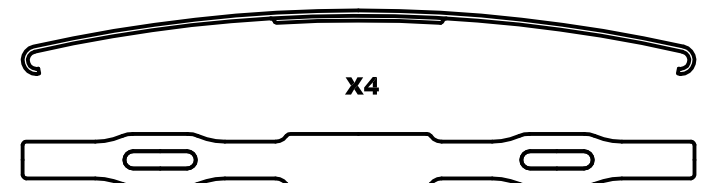

ACB-101

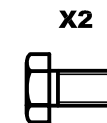

PAS-632

WVA 29173

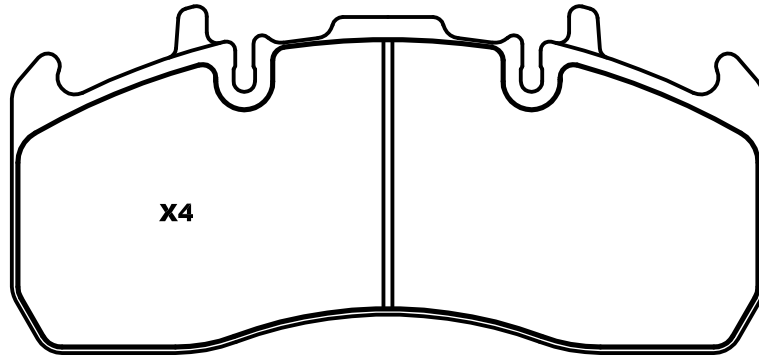
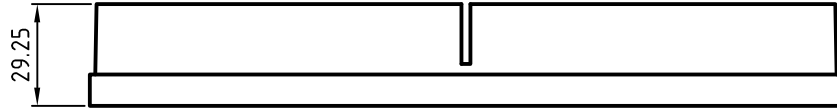

ACC-814

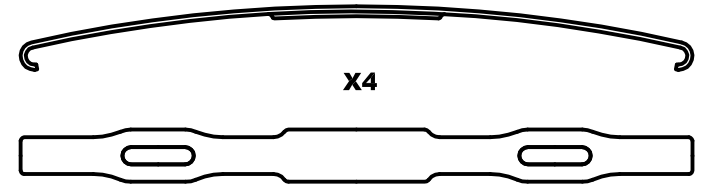

ACB-101

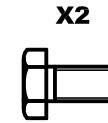

PAS-667

WVA 29246

WVA 29247

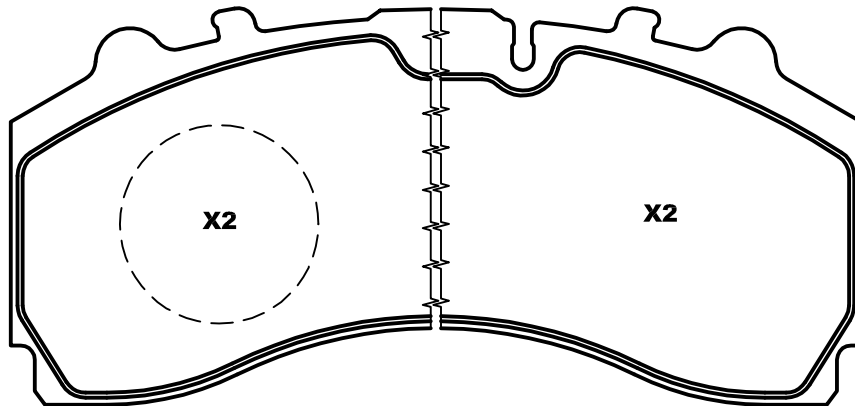
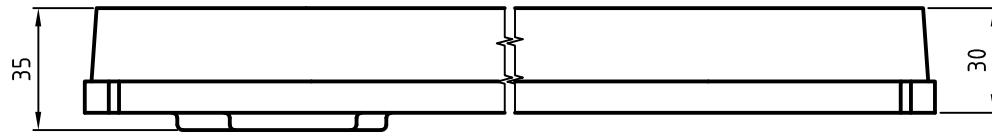

ACC-801

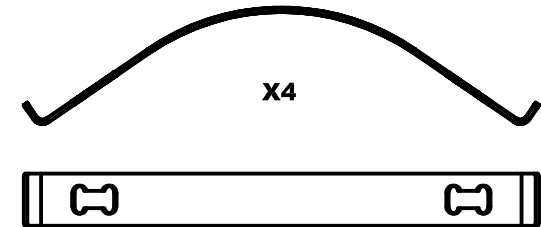

ACK-101

X1



X2



X2

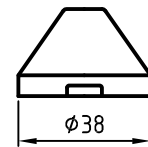

X2

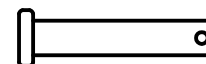

X2



X2



PAS-668

WVA 29244

WVA 29245

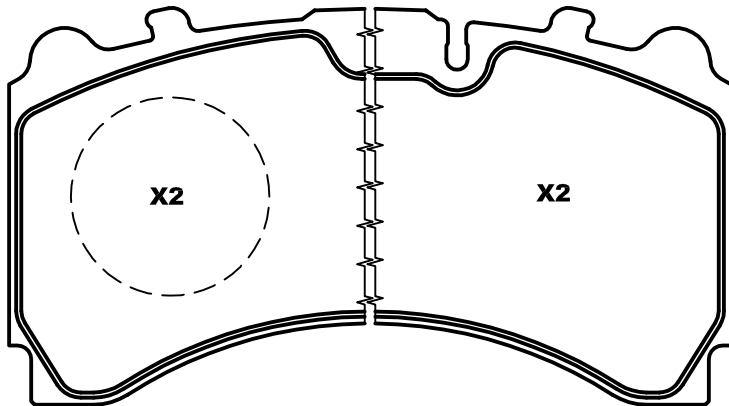
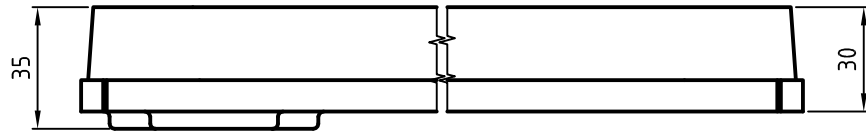

ACC-801

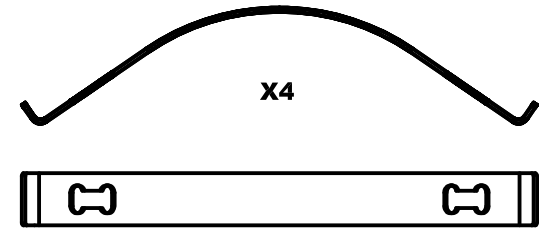

ACK-101

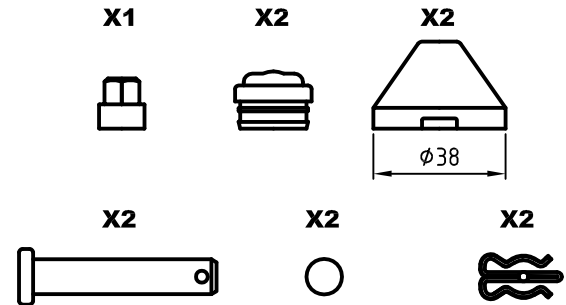

PAS-669

WVA 29228

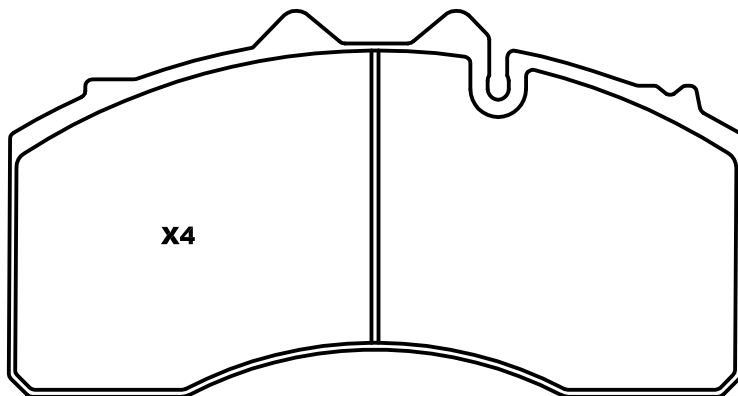
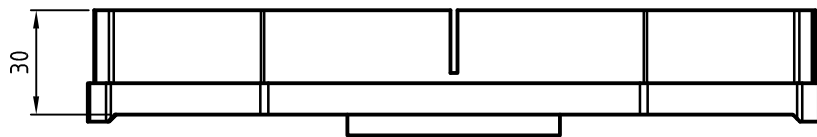

ACK-119

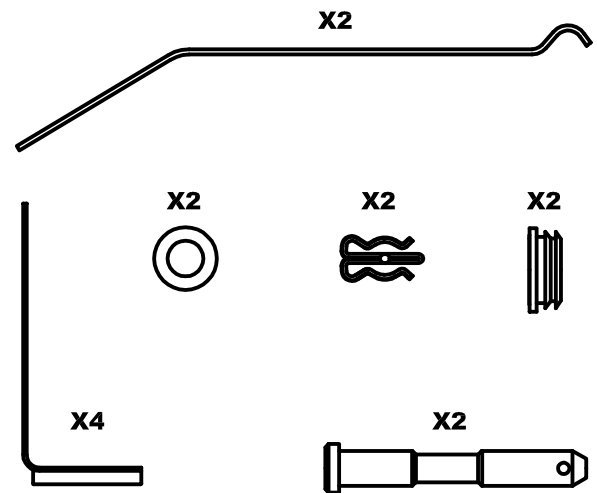

PAS-670

WVA 29227

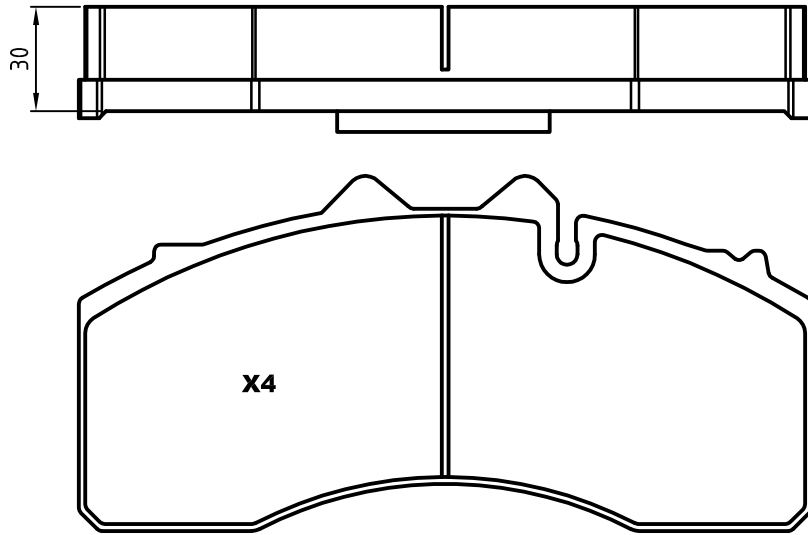

ACK-118

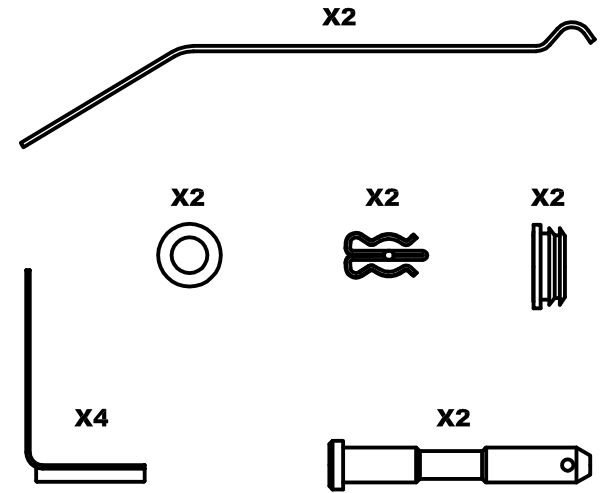

PAS-682

WVA 29274

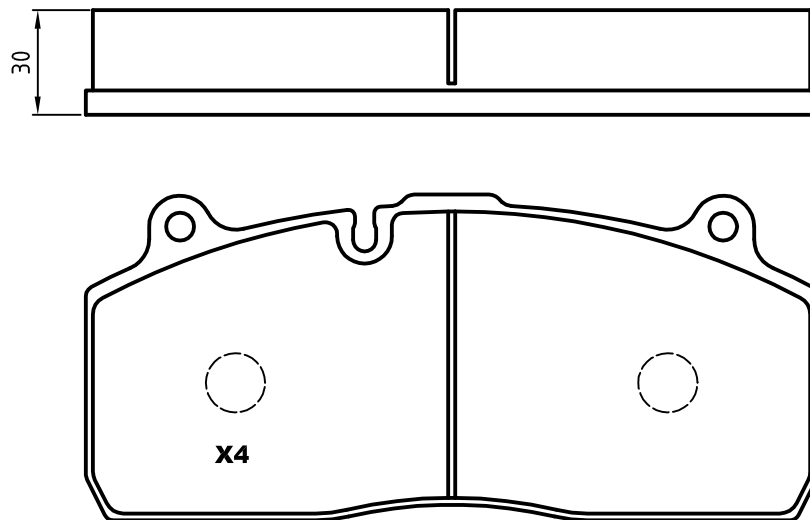

ACC-823

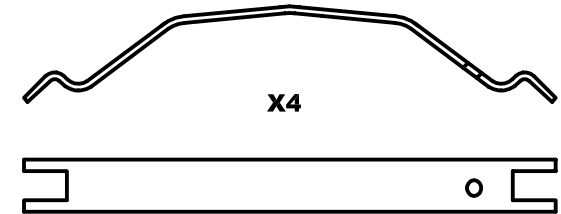

NO KIT

PAS-683

WVA 29211

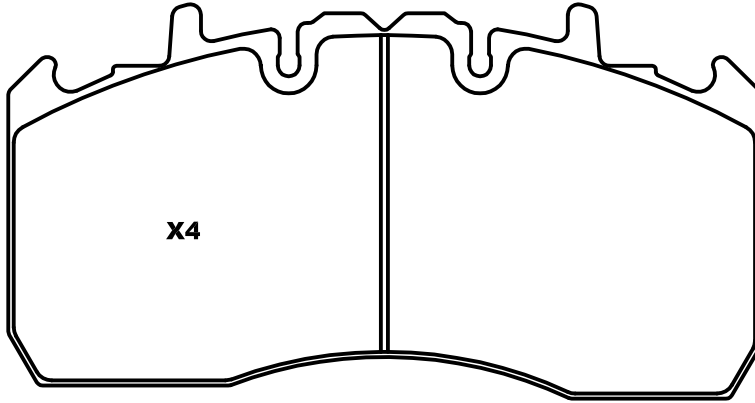
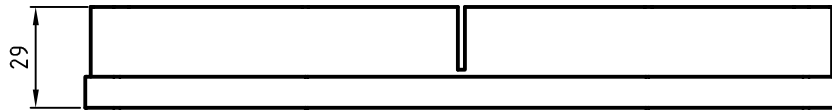

ACC-814

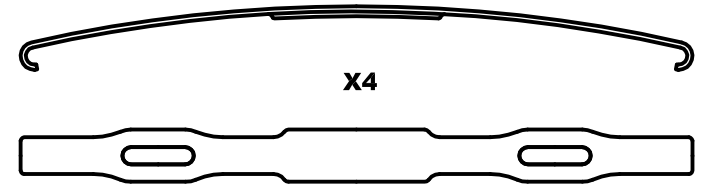

ACB-101

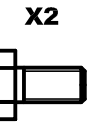

PAS-695

WVA 29279

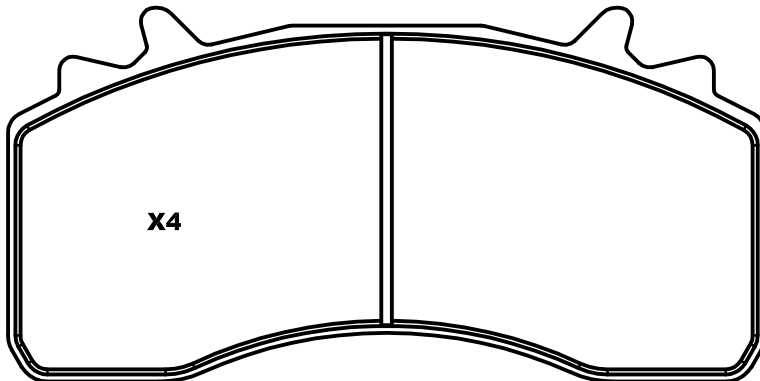
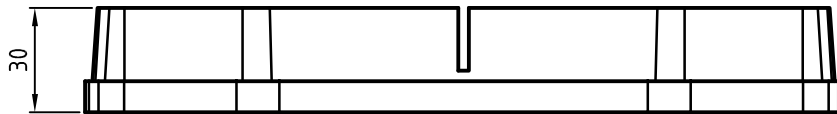

ACK-221

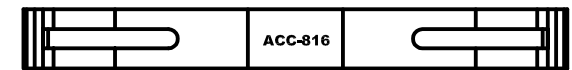
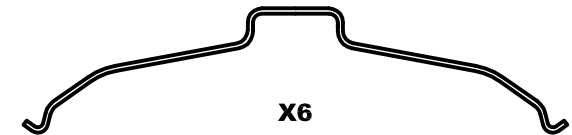

PAS-703

WVA 29187

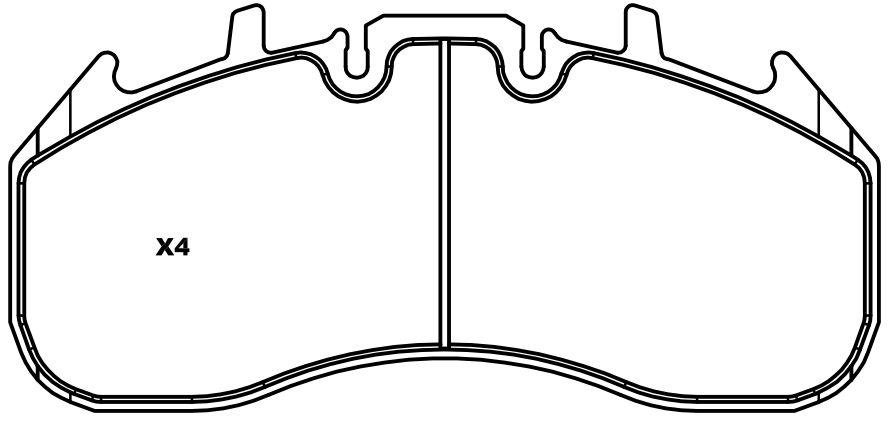
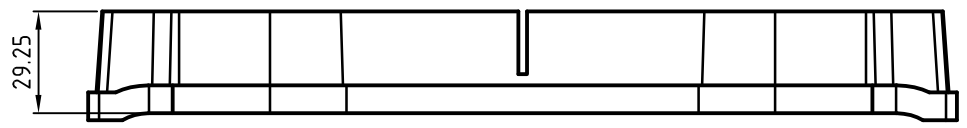

ACC-814

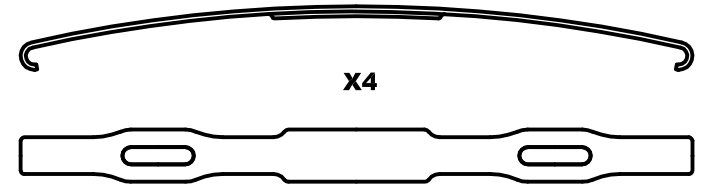

ACB-101

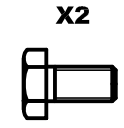

PAS-704

WVA 29254

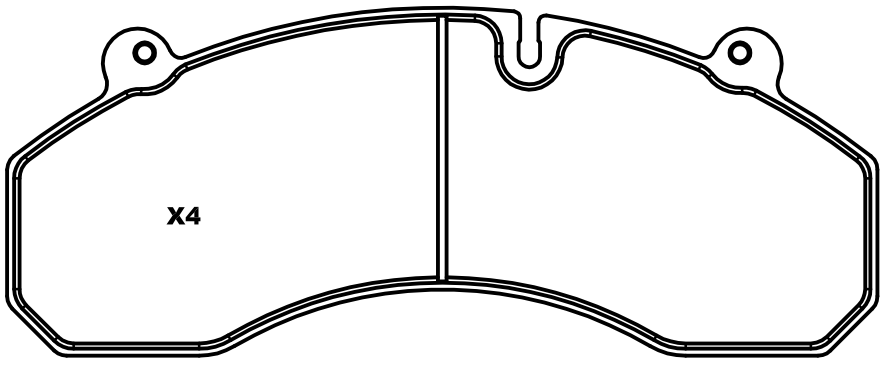
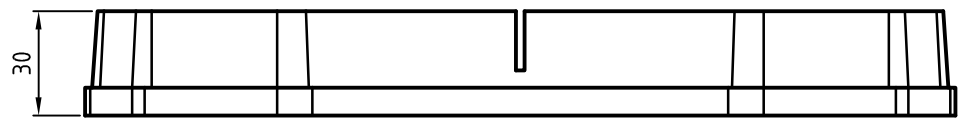

ACC-813

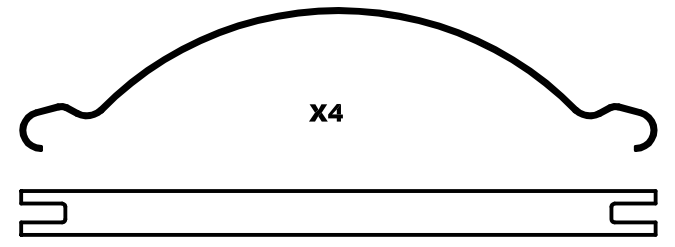

NO KIT