

OM 401

Mercedes-Benz Motorbaumuster

Mercedes-Benz Engine Model | Modèle de moteur Mercedes-Benz | Modelo

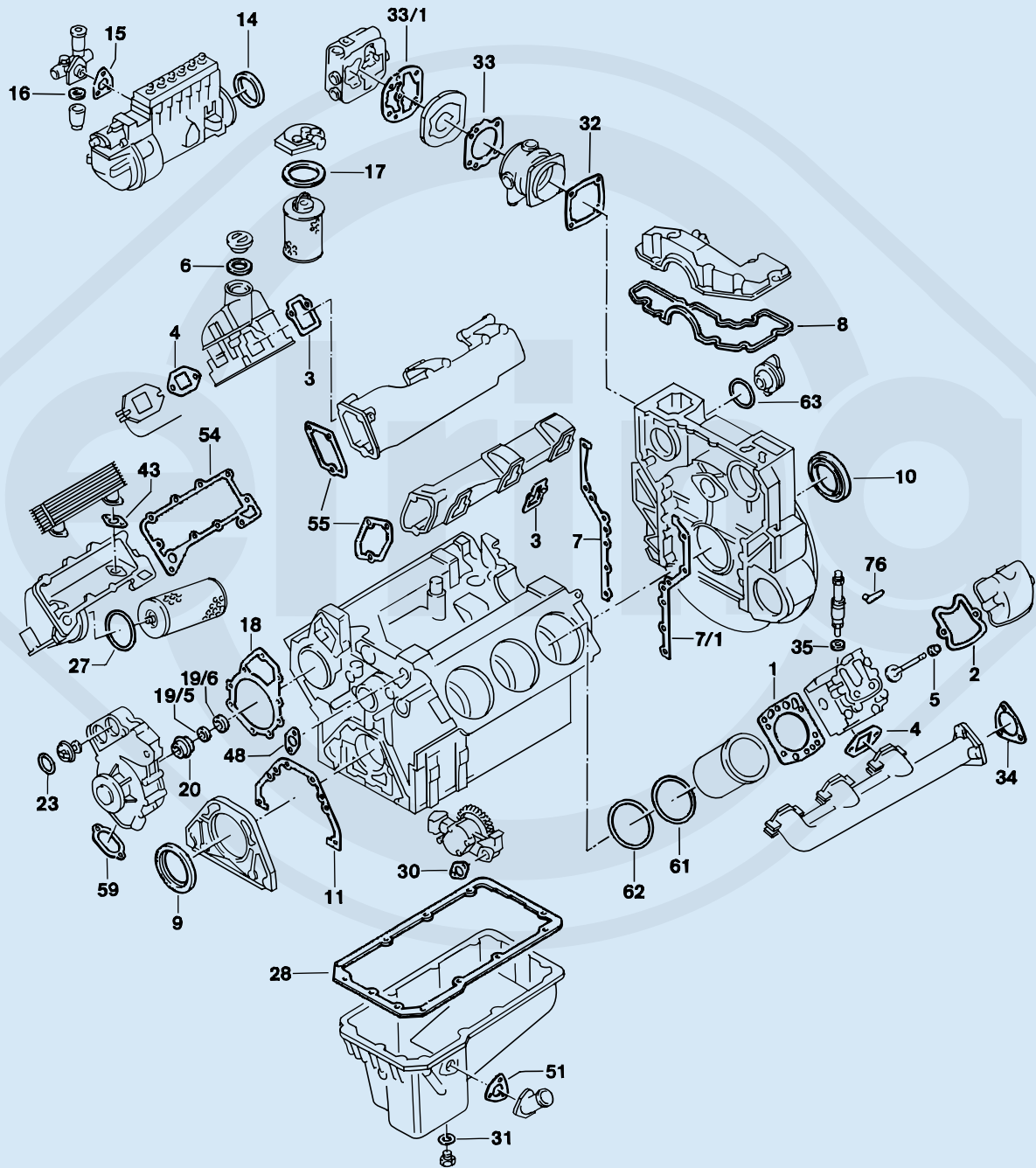

de motor Mercedes-Benz

Bild-Nr. Fig. No. No d'illustration Nº figura	Elring-Nr. Elring reference Référence Elring Referencia Elring	Stück Pieces Pièces Piezas	Teile-Nr. Part Number Référence Referencia	Bauart Material Abmessung Type Material Dimensions Type matériau dimension Tipo Material Medidas	Bemerkung Remarks Remarque Notas
S *	826.502	1	-	-	-
ZLBS	827.533	6	-	-	Zylinderlaufbuchse cylinder liner chemise camisa Ø 143 mm
ZLBS	827.541	6	-	-	Zylinderlaufbuchse cylinder liner chemise camisa Ø 145,8 mm → Mot. 535118
ZLBS	827.568	6	-	-	Ø 145,8 mm Mot. 535119 → incl. Tombak
ES	812.544	6	444 010 01 20	-	Mot. 001207 → incl. 896.510
ES	812.545	6	444 010 01 20	-	Mot. 001207 → incl. 412.180
ES	812.529	6	-	-	Mot. 001207 → incl. 748.080
ES	413.810	6	-	-	Mot. 001207 → incl. 896.510
CS *	812.560	1	421 010 04 08	-	-
WPS	812.609	1	403 200 69 01	-	→ Mot. 257475 für for pour para 16 Ø mm Welle shaft arbre árbol
WPS	812.617	1	422 200 09 01	-	Mot. 257476 → für for pour para 15 Ø mm Welle shaft arbre árbol
SZ	812.552	1	423 010 48 33	-	Steuergehäuse timing case carter de distribution cubierta de la distribución
LPS	061.460	1	402 130 02 20	-	-
LPS	127.550	1	-	-	-
ZKS	820.083	6	-	-	→ Mot. 130555
ZKS	820.091	6	-	-	Mot. 130556 →
1	748.080	6	422 016 06 20	143,5 Ø, 1,23 mm	-
1	748.110	6	422 016 07 20	143,5 Ø, 1,33 mm	Reparaturstufe repair size cote de réparation nivel de reparación
1	896.510	6	442 016 03 20	143,5 Ø, 1,25 mm	-
1	412.180	6	442 016 04 20	143,5 Ø, 1,25 mm	-
2	193.640	6	403 016 01 21	-	→ Mot. 001206
2	977.438	6	442 016 06 21	-	Mot. 001207 →
3	896.365	6	442 141 17 80	-	-
4	225.126	6	403 142 03 80	-	-
5	562.297	12	422 053 01 96	12x15,7/20x15 FPM	-
5	193.658	12	403 053 00 96	12x15,7/20x15 ACM	-
6	a.A.	1	352 018 01 80	37x59,5x3 Kork/CP	-
7	819.190	1	442 015 01 80	-	-
7/1	819.204	1	442 015 00 80	-	-
8	759.139	1	442 015 00 60	-	-
9	524.973	1	014 997 46 47	AW/BS RD FPM 105x130x12	-
10	562.920	1	013 997 14 47	AW/BS LD FPM 120x140x13	-
11	756.768	1	442 011 00 80	-	-
14	759.147	1	442 074 00 59	94,5x105,3x9 ACM PR	-
15	a.A.	1	001 074 22 80	-	-
16	716.200	1	000 997 00 40	28x36x2 NBR A	-
17	731.269	2	000 477 35 80	-	→ Mot. 252381
17	733.431	1	000 477 31 80	-	Mot. 252382 →
18	775.983	1	442 201 10 80	-	→ Mot. 129660
18	756.881	1	442 201 00 80	-	Mot. 129661 →
19/5	a.A.	1	000 201 04 63	-	für for pour para 16 Ø mm Welle shaft arbre árbol
19/6	190.608	1	000 201 01 97	-	für for pour para 16 Ø mm Welle shaft arbre árbol